



# **FLUID MACHINERY AND ENERGY SYSTEMS RESEARCH GROUP**

**Dipartimento di Ingegneria  
Università degli Studi di Ferrara (ITALY)**

# STAFF

Name	Position
Pier Ruggero Spina (pier.ruggero.spina@unife.it)	Full professor
Michele Pinelli (michele.pinelli@unife.it)	Associate professor
Mauro Venturini (mauro.venturini@unife.it)	Associate professor
Five Ph.D. students	
Two research associates	

# Overview of the research activity

1. Gas turbines
2. CHP plants (both large-size and micro-scale applications)
3. CFD analysis of turbomachinery and combustion
4. Experimental activity
5. Energy production from renewable sources

# Overview on the research activity - main themes (1/5)

## 1a. Gas turbines

- Diagnostics and prognostics
  - Trend Analysis of normalized measurements
  - Health Indices from Gas Path Analysis
  - Neural networks and neuro-fuzzy networks

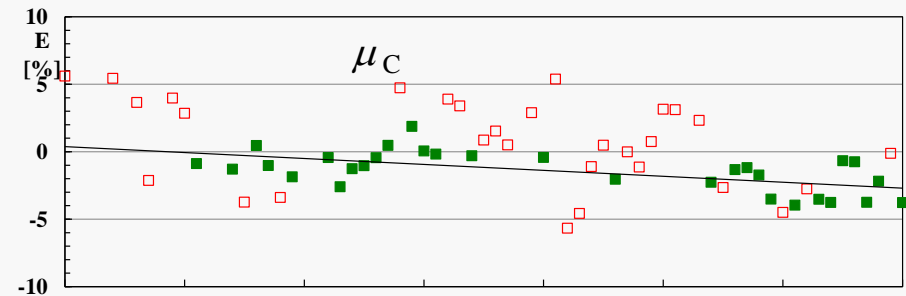
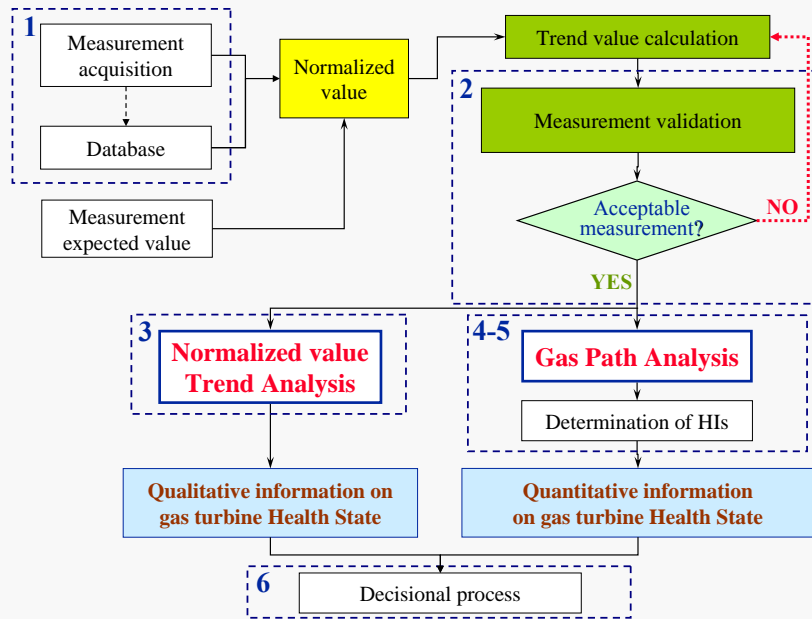

The methodology based on Gas Path Analysis allows the identification of the current health state of the gas turbine (diagnostics through Health Indices). The prediction of the future health state of the gas turbine is made by means of a statistical approach (prognostics through Monte Carlo simulation).

# Overview on the research activity - main themes (1/5)

## 1a. Gas turbines

### • Modeling

- Steady-state performance (both physics-based and black-box models)
- Dynamic behavior (surge modeling, recurrent neural networks, hybrid model)

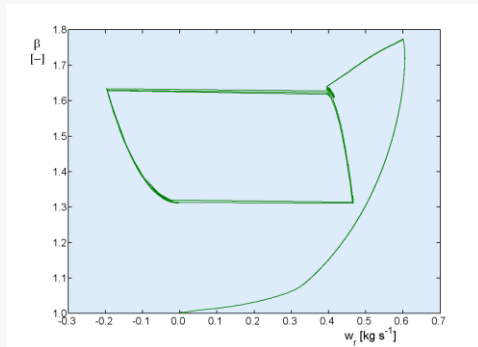
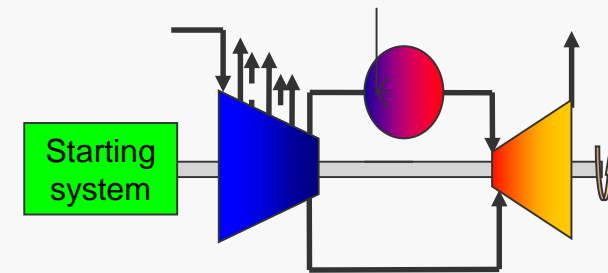
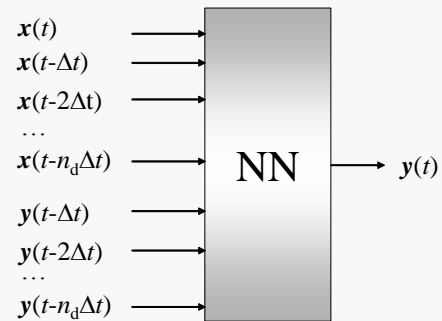
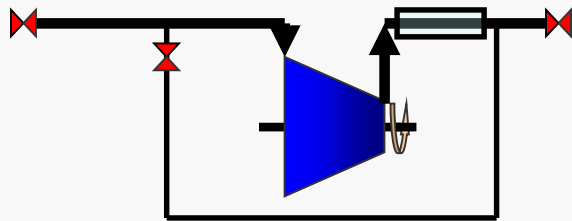

Dynamic model for surge prediction and control

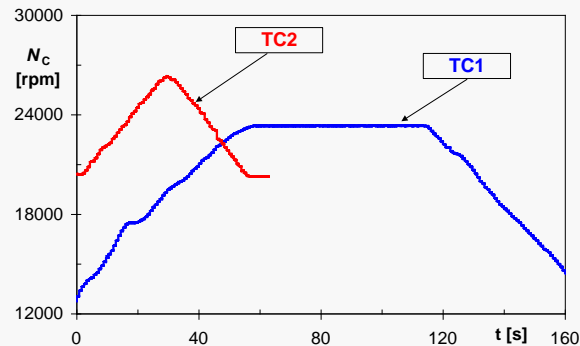

Recurrent Neural Network model for compressor dynamics

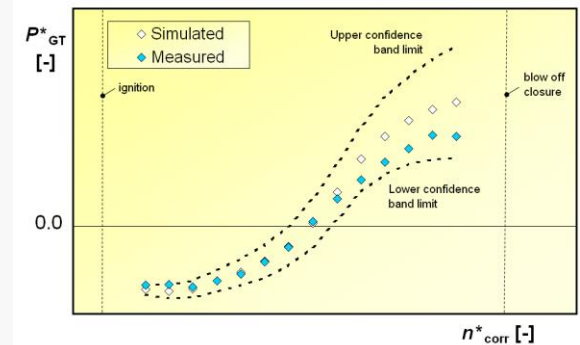

Quasi-steady model for gas turbine start-up simulation

# Overview on the research activity - main themes (2/5)

## 2. CHP and micro-CHP

- Thermodynamic efficiency, economic analysis, system optimization
- Industrial CHP
- Micro-CHP systems for household applications

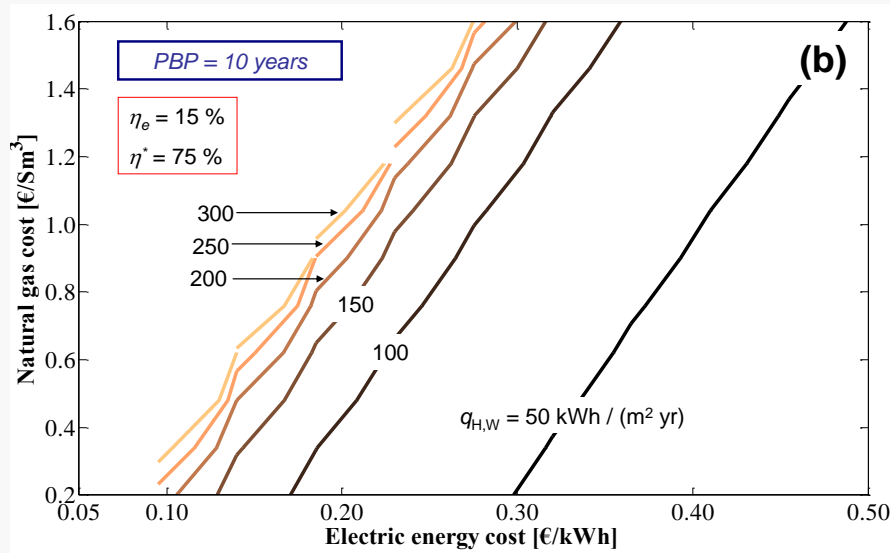

Study on economic feasibility of micro-CHP systems, as a function of economic parameters (fuel cost and electric energy price), CHP performance (electric and thermal efficiency) and user thermal energy demand

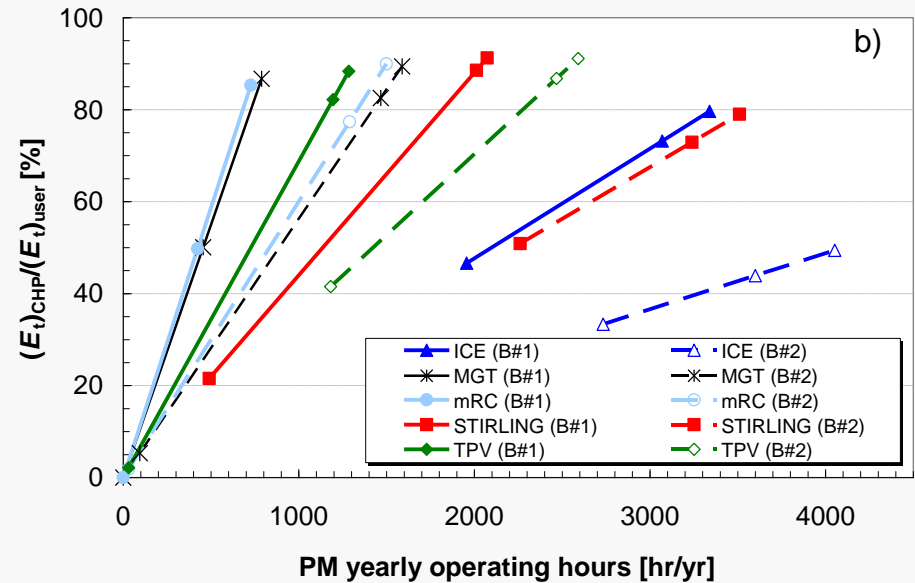

Thermal energy demand of the user met by the CHP system for several micro-CHP technologies (Internal Combustion Engine, Micro Gas Turbine, micro-Rankine Cycle, Stirling Engine, Thermo-PV generator)

# Overview on the research activity - main themes (2/5)

## 2. CHP and micro-CHP

- Analysis of micro-energy-systems for residential users
- Load optimal allocation and sizing of multi-source energy systems

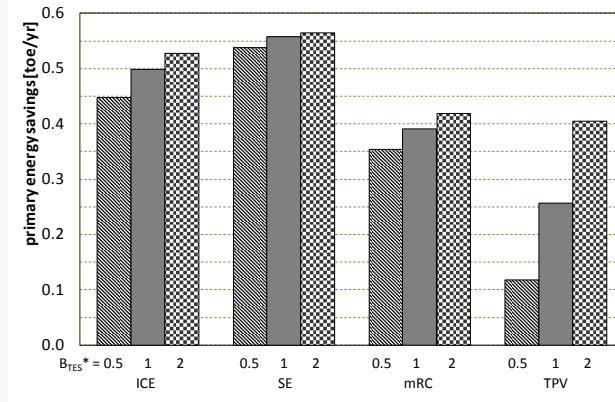
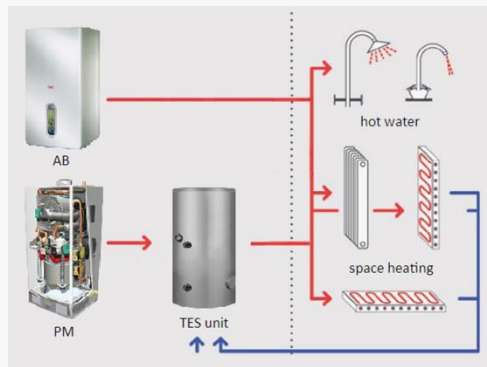

Energy and economic analysis of different micro-energy-systems fed with fossil and renewable fuels, to meet the demand of electric/thermal/cooling energy of residential users

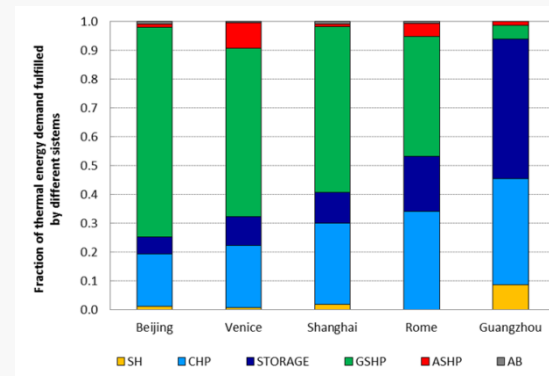
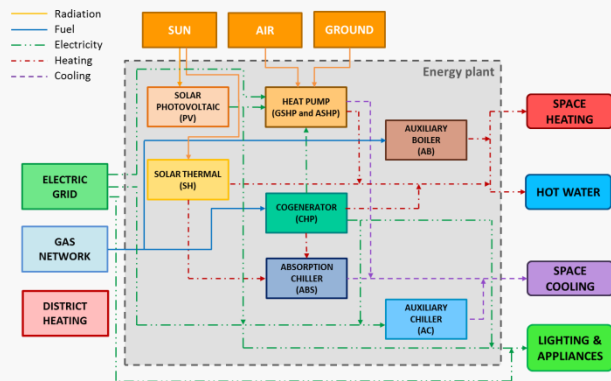

For the micro-energy-systems considered above, the optimal load allocation is identified to maximize the primary energy saving, under full/part load

# Overview on the research activity - main themes (3/5)

## 3. CFD analysis

- Design of turbomachines (pumps, compressors, blowers)
- CFD analysis of compressor fouling

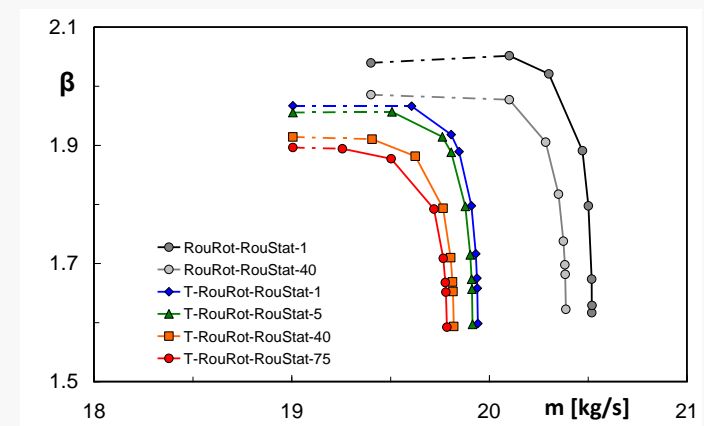
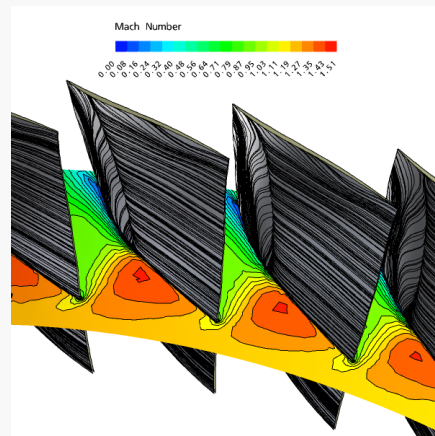
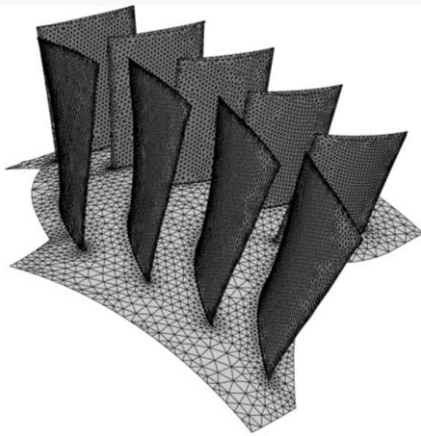

- Study of combustion processes in energy systems
- Gas turbine combustion simulation (also biofuels)

Prediction of both local and global influence on turbomachine performance



# Overview on the research activity - main themes (3/5)

## 3. CFD analysis (biofuel combustion)

- Numerical analysis of the combustion process within a Micro Gas Turbine



(a)

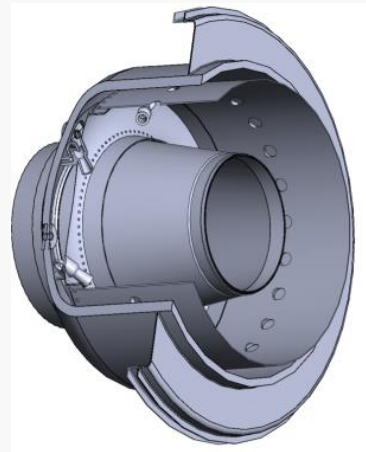

(b)

3D thermo-fluid dynamic simulations of the combustion process in a Solar T-62T-32 turbine, by means of a commercial CFD software  
Considered fuels: natural gas, syngas, liquid biofuels (rapeseed and soybean oils)

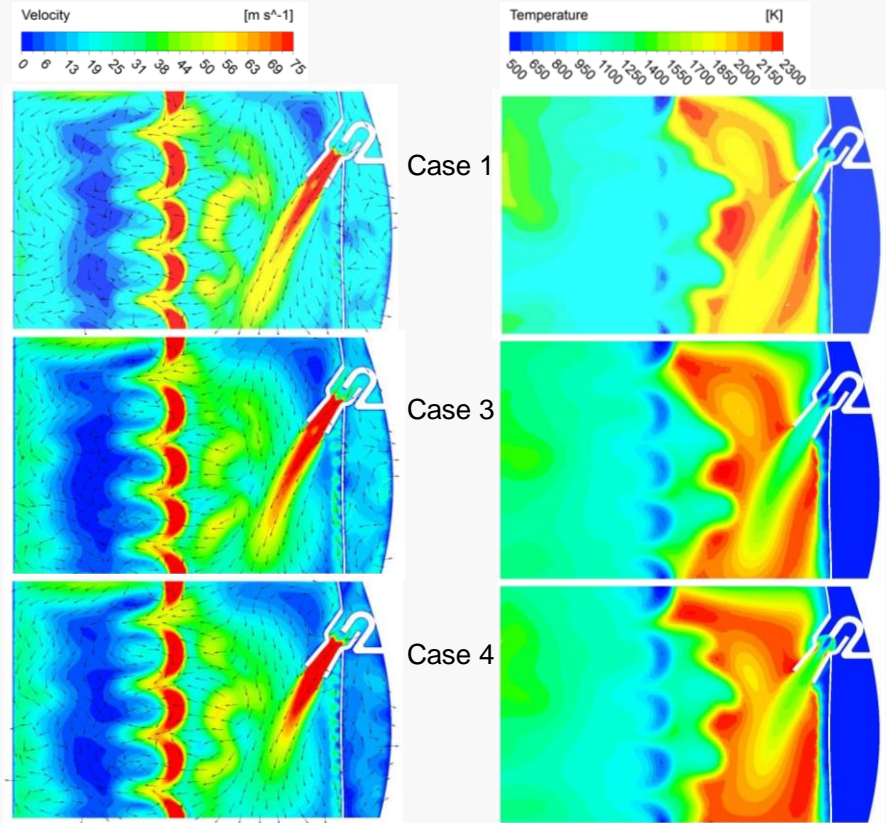

# Overview on the research activity - main themes (4/5)

## 4. Experimental activity

- Test bench for compressor characterization
- Acquisition and post-processing of thermo-fluid-dynamic, acoustic and vibration measurements
- Wet compression investigation to characterize compressor operation and performance

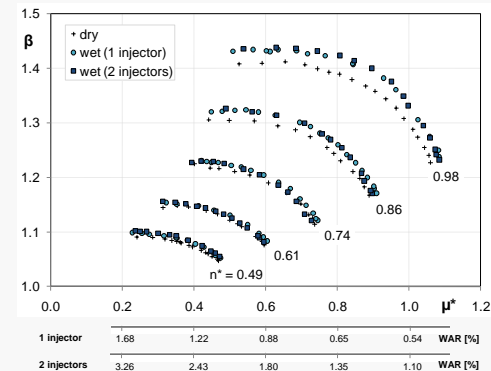
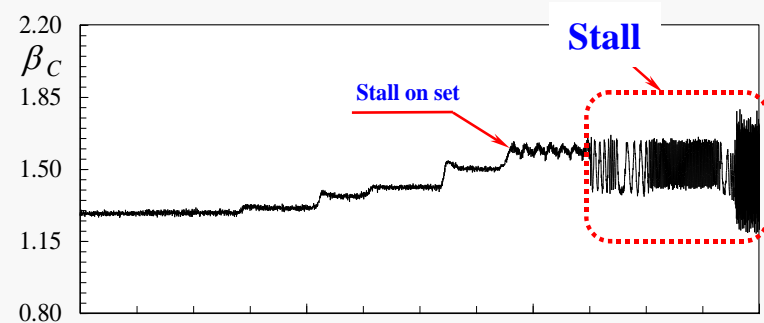

	1.68	1.22	0.88	0.65	0.54	WAR [%]
1 injector						
2 injectors	3.26	2.43	1.80	1.35	1.10	WAR [%]

# Overview on the research activity - main themes (5/5)

## 5. Energy production from renewable sources

- Thermodynamic, thermo-economic and fluid-dynamic analyses of energy systems fed with biofuels, to optimize energy performance and improve economic feasibility
- Modeling of the entire process from biomass to energy production

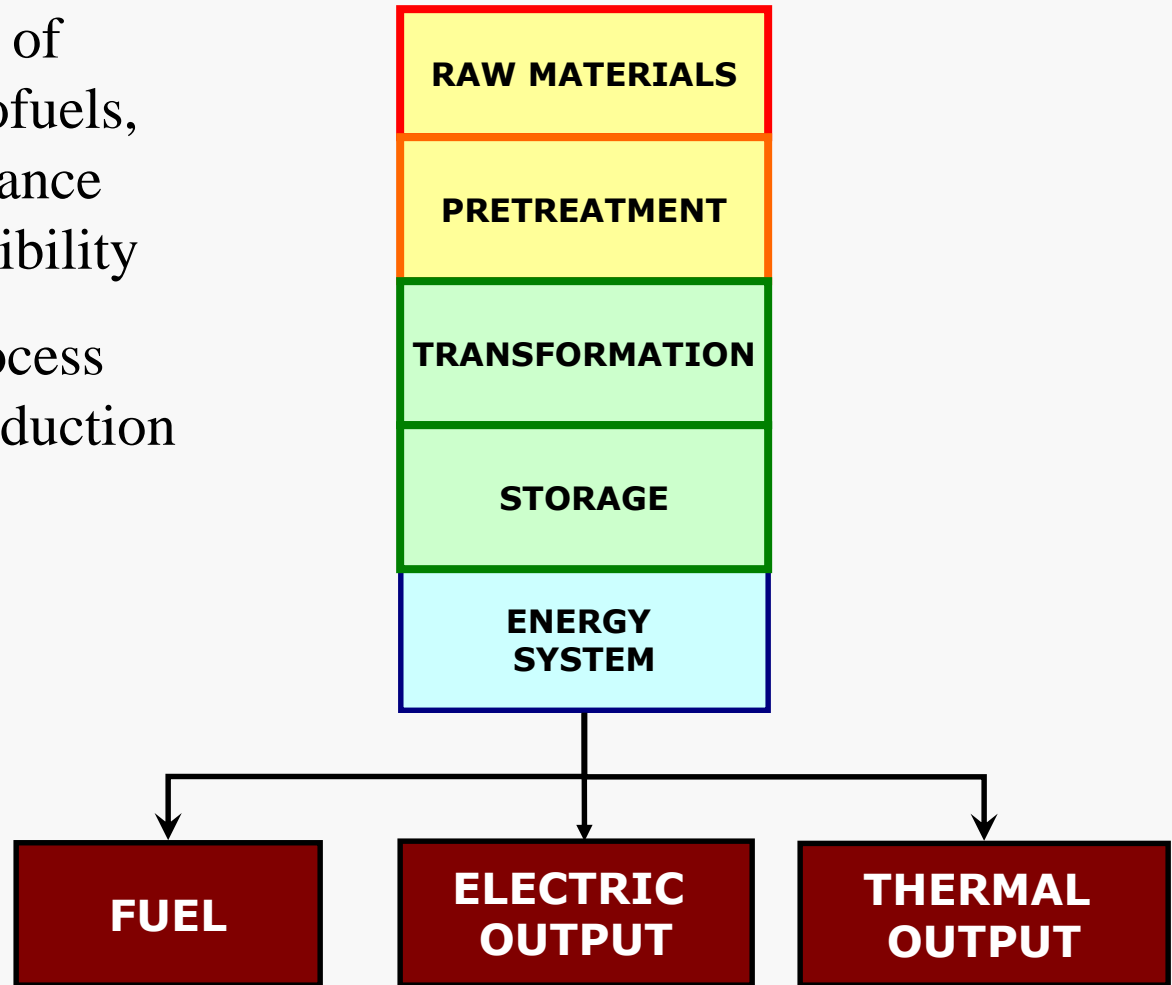

# Overview on the research activity - main themes (5/5)

## 5. Energy production from renewable sources

- Assessment of Current and Future Energy Potential from Biomass (Country level)

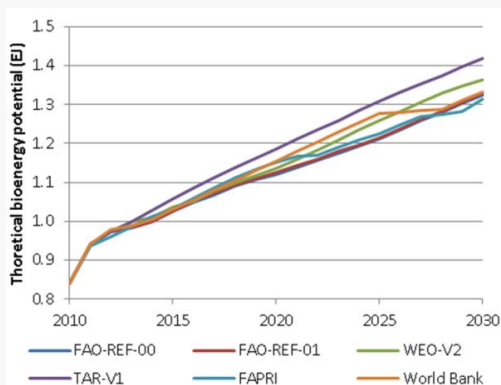

This research activity aims to identify the current energy potential from biomass, on the basis of available biomass, climate conditions, land use change, policy, etc.

Projections (see the picture) are made according to different scenarios (e.g. made by the World Bank and FAO), which account for GDP, demography, policy, etc.

- Comparative Evaluation of Bioenergy Chains (e.g. for Emilia-Romagna)

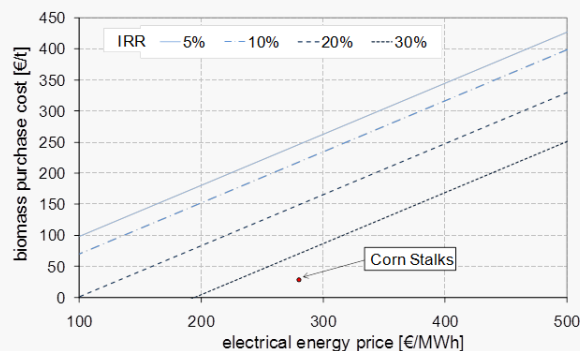
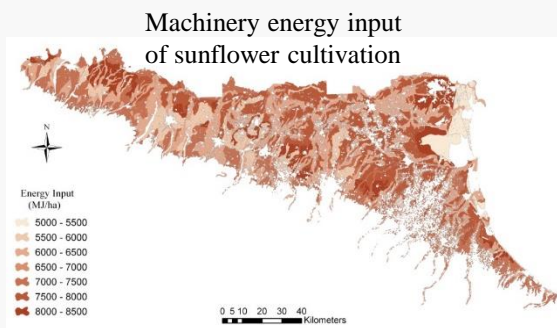

Energy and economic evaluation of different energy chains (e.g. sunflower and rapeseed oil, thermochemical conversion, biogas use, exploitation of agricultural wastes, etc.)

# Overview on the research activity - main themes (5/5)

## 5. Energy production from renewable sources

- Energy and Economic Analyses of Integrated Biogas-Fed Energy Systems (anaerobic digestion of corn and OFSMW) – experimental and modeling activity carried out to identify the optimal energy chain

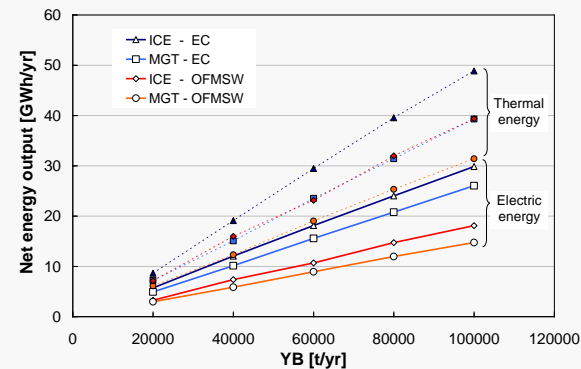
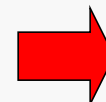
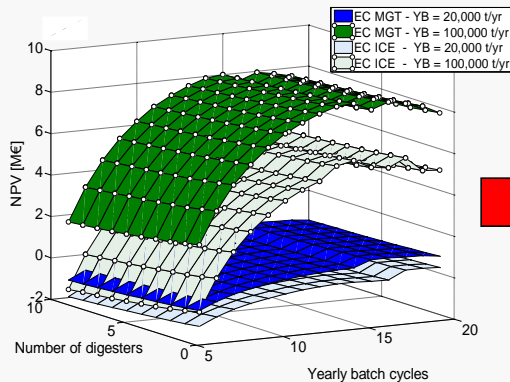
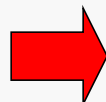
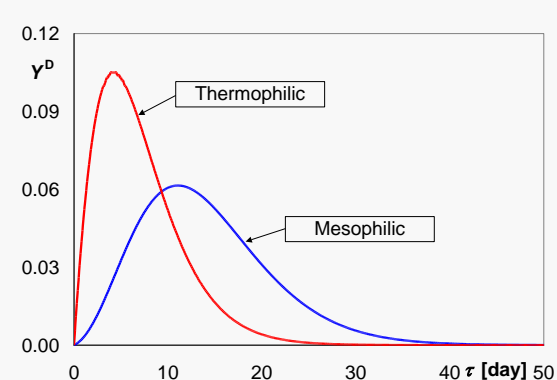
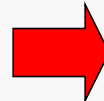
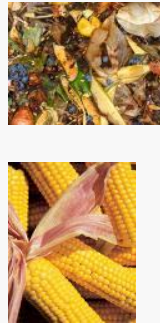
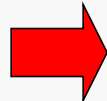
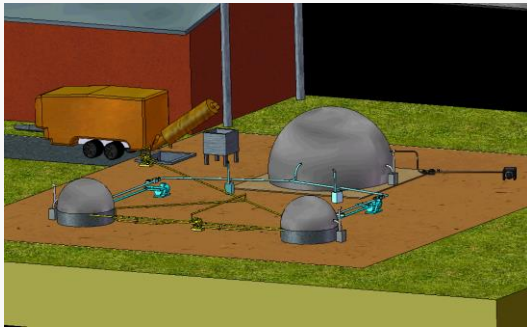

# Overview on the research activity - main themes (5/5)

## 5. Energy production from renewable sources

- Experimental analysis of a Micro Gas Turbine fed with vegetable oil

Energy crops

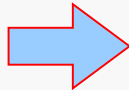

Vegetable oils

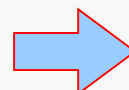

MGT-based  
CHP system

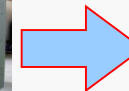

50 kW<sub>el</sub>



2500 l/h  
@ 50 °C

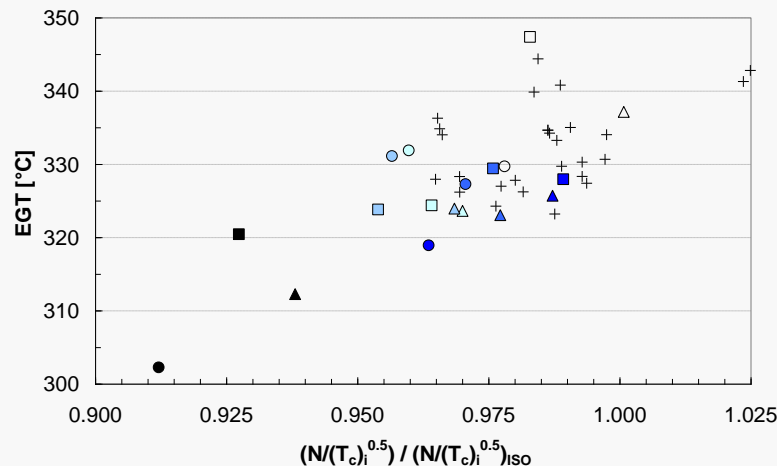

- Cultivation of energy crops
- Vegetable oil production
- Testing on a MGT
- Experimental analysis of the performance of the MGT fed with vegetable oil (e.g. influence on Exhaust Gas Temperature for different working points)

# Research contracts (1/3)



**GE Nuovo Pignone (1997)** - *Development of a methodology for gas turbine operating state analysis*



**ENI (1999)** - *Application of a diagnostic system to mechanical drive small-size gas turbines for NG compression*



**ENEL (2001)** - *Development of a diagnostic system for industrial large-size gas turbines*



**CESI (2004)** - *Application of neural networks for the diagnostics of industrial gas turbines*

# Research contracts (2/3)



**HERA (2005)** - *Waste and biomass treatment for biogas production for power and thermal generation*



**ENEA (2008 & 2010)** - *Innovative and efficient technologies for micro-CHP*



**CNR (2009 - 2013)** - *Numerical investigation of combustion in a micro-gas-turbine fed with gaseous biofuels*

**CNR (2013 - 2014)** - *Optimal sizing of multi-source energy plants for power heat and cooling generation*



**ENIPOWER (2010)** - *Analysis of the health state of gas turbines*



**GE Global Research (2013)** - *Deployment of sustainable, non-food competing and environmentally benign biofuel and biomass technologies*



# Research contracts (3/3)

